

Diritti riservati All rights reserved

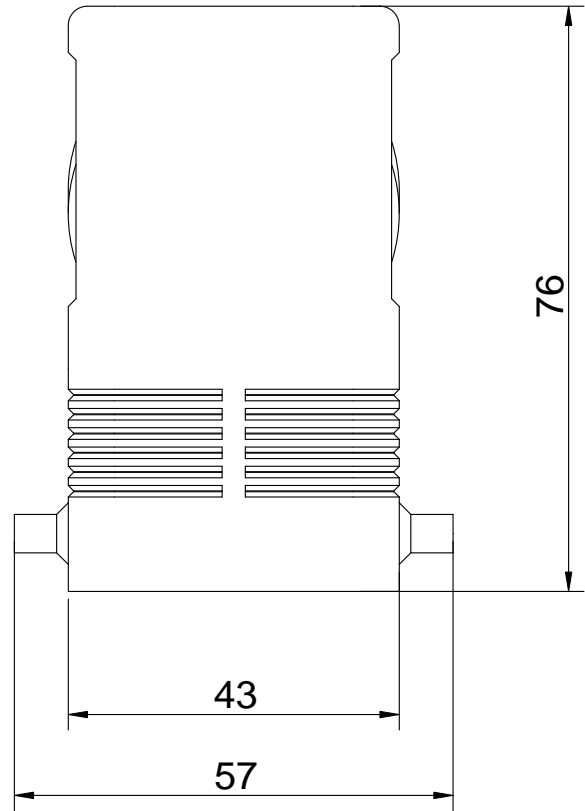
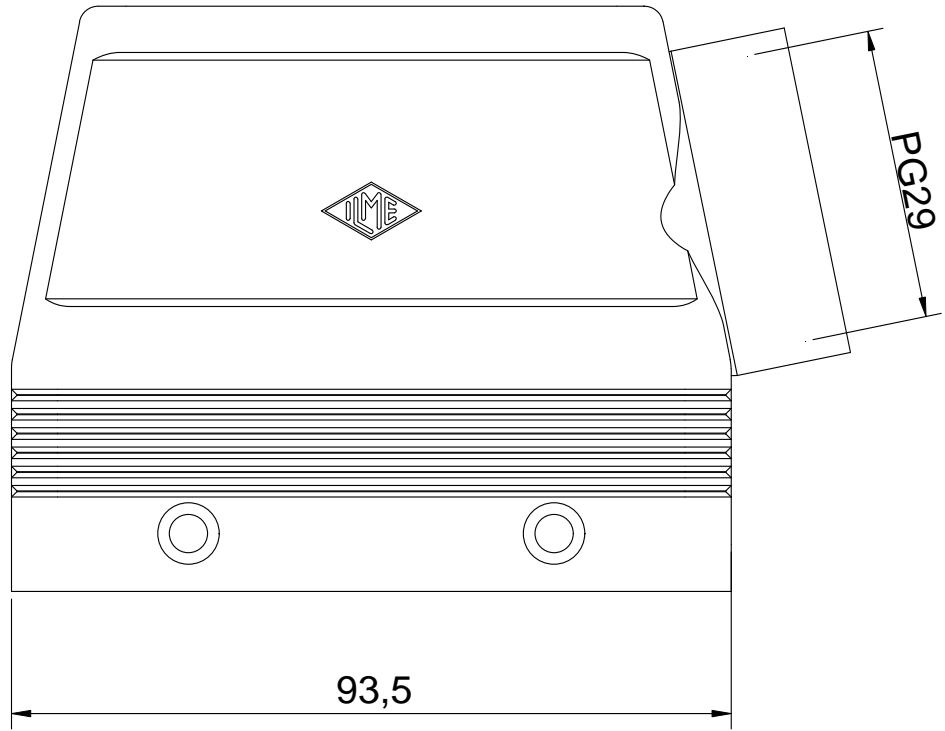

Date 14.12.2006	CMAO 06.29		Scale
Sign.	hood side entry PG29 ins.		1:1
			